



5 60 449 0

basis Sound island Monk





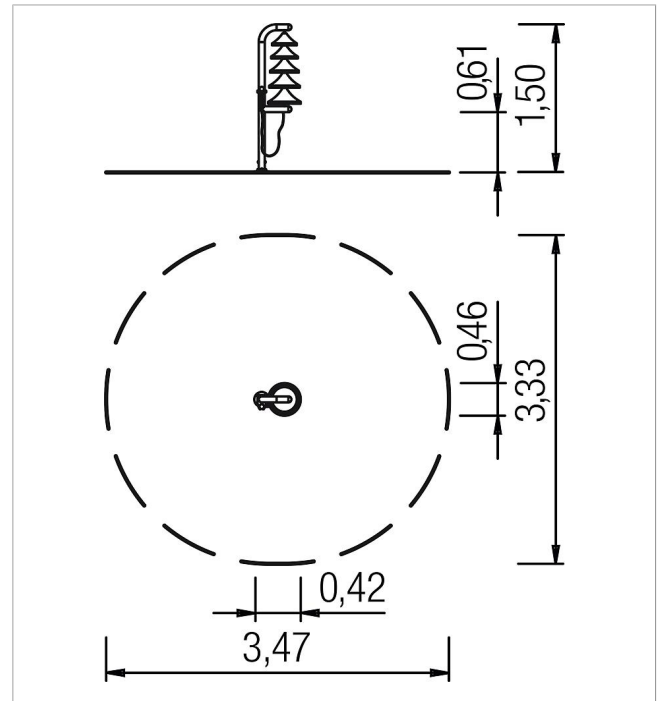

made in germany

3+

Scope of delivery

1x sound island Monk: powder-coated steel, stainless steel (V2A)



	Material	Powder-coated steel, stainless steel
	Foundation level	FL 3
	Minimum space	343x333x180 cm
	Free falling height	-
	Impact protection net	-
	Foundations	1x CF
	Largest section	43x33x155 cm