



5 67 223 0

Basis Spring rocker Gondola







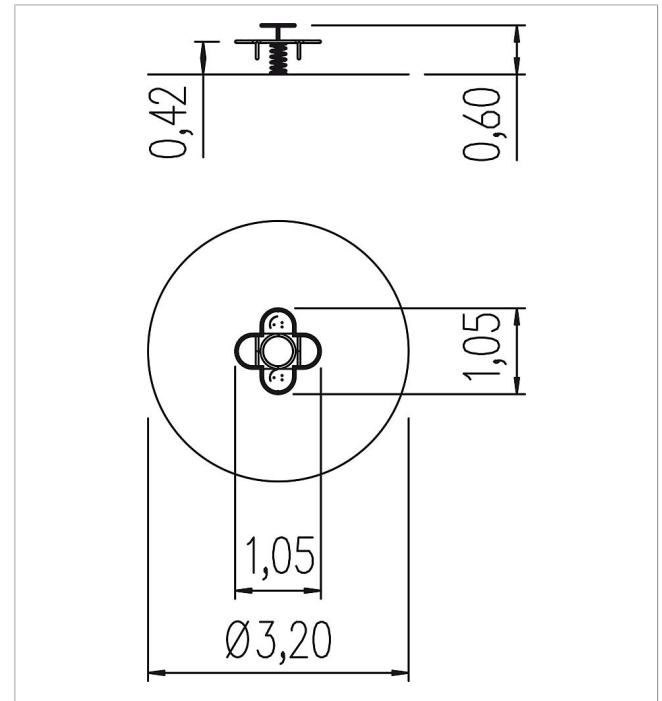

made in germany



Scope of delivery

1x frame: stainless steel
2x springs: spring steel



	Material	Stainless steel
	Foundation level	FL 3
	Minimum space	Ø 320x222 cm
	Free falling height	42 cm
	Impact protection net	8,5 m ²
	Foundations	2x 5632280 + 1x CF
	Assembly	1 person/1 h
	Largest section	113x113x43 cm
	Heaviest section	50 kg