

5 67 256 0

## Basis Spring rocker Rattle Box







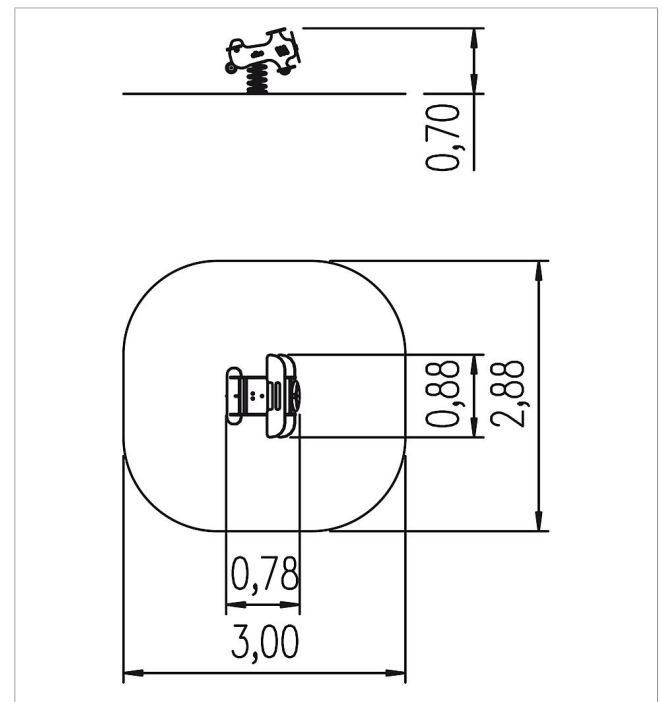

made in germany



### Scope of delivery

1x spring see-saw-body: HPL  
1x spring: spring steel



	Material	HPL
	Foundation level	FL 3
	Minimum space	300x288x222 cm
	Free falling height	42 cm
	Impact protection net	8,0 m <sup>2</sup>
	Foundations	1x 5632280 + 1x CF
	Assembly	1 person/1 h
	Heaviest section	-