



5 67 219 0

## Basis Spring rocker Recliner







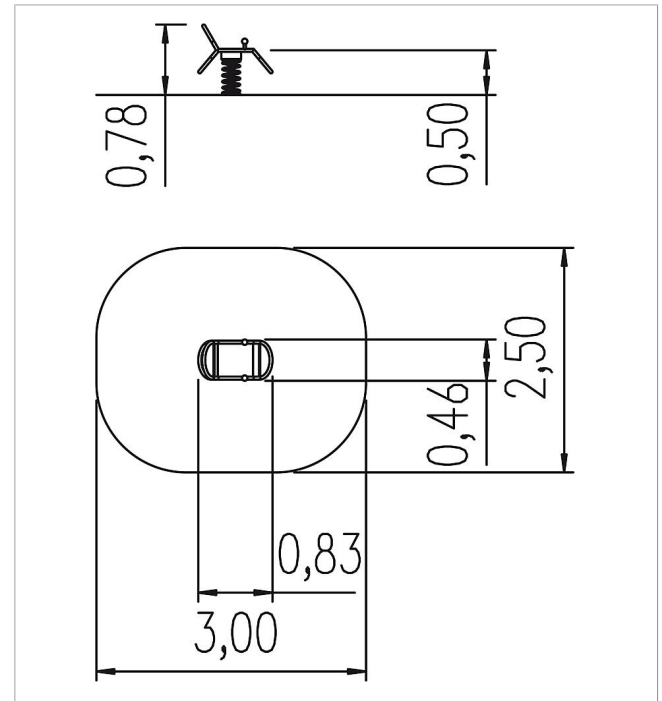

made in germany



### Scope of delivery

- 1x frame: stainless steel
- 1x spring: spring steel



	Material	Stainless steel
	Foundation level	FL 3
	Minimum space	300x250x233 cm
	Free falling height	50 cm
	Impact protection net	7,5 m <sup>2</sup>
	Foundations	1x 5632280 + 1x CF
	Assembly	1 person/1 h
	Largest section	83x46x54 cm
	Heaviest section	30 kg