



5 67 125 0

Basis Spring rocker Snake







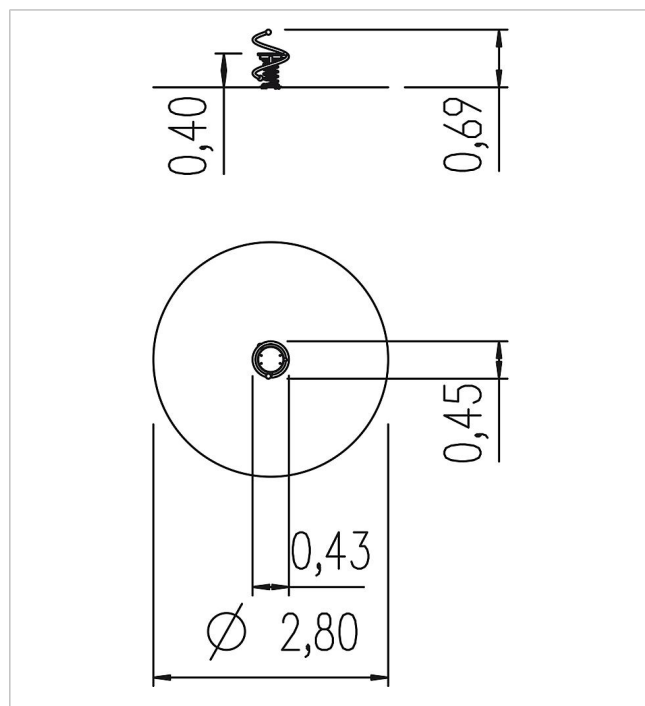

made in germany



Scope of delivery

- 1x spring see-saw-body: powder-coated steel
- 1x seat: PE
- 1x spring: spring steel



	Material	Steel, PE
	Foundation level	FL 3
	Minimum space	Ø 280x240 cm
	Free falling height	40 cm
	Impact protection net	6,5 m ²
	Foundations	1x 5591600 + 1x CF or 1x 5632100 + 1x CF
	Assembly	1 person/1 h
	Largest section	73x48x45 cm
	Heaviest section	30 kg