



5 67 244 0

Basis Spring rocker Whale







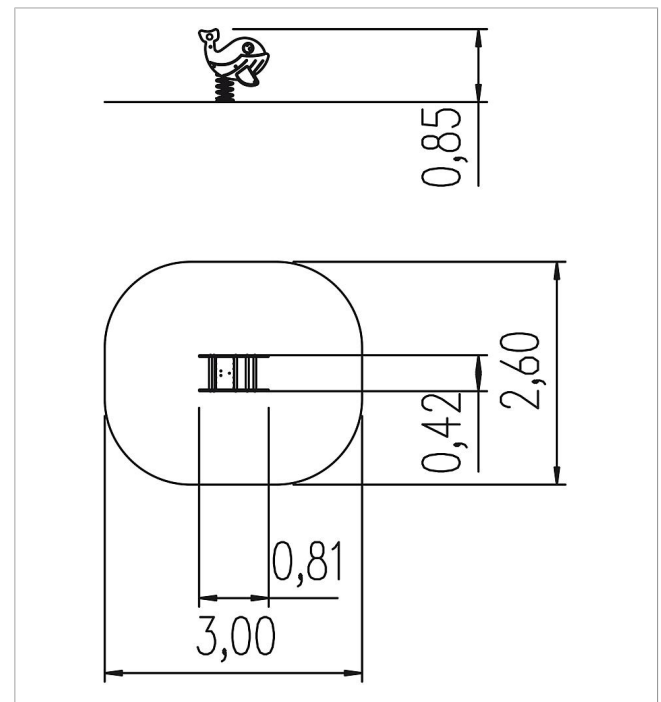

made in germany



Scope of delivery

1x spring see-saw-body: HDPE
1x spring: spring steel
Hand and foot holds: stainless steel



	Material	HDPE
	Foundation level	FL 3
	Minimum space	300x260x222 cm
	Free falling height	42 cm
	Impact protection net	7,0 m ²
	Foundations	1x 5632280 + 1x CF
	Assembly	1 person/1 h
	Largest section	81x66x43 cm
	Heaviest section	30 kg