



5 10 074 0110 0

## playo swing frame Kondor





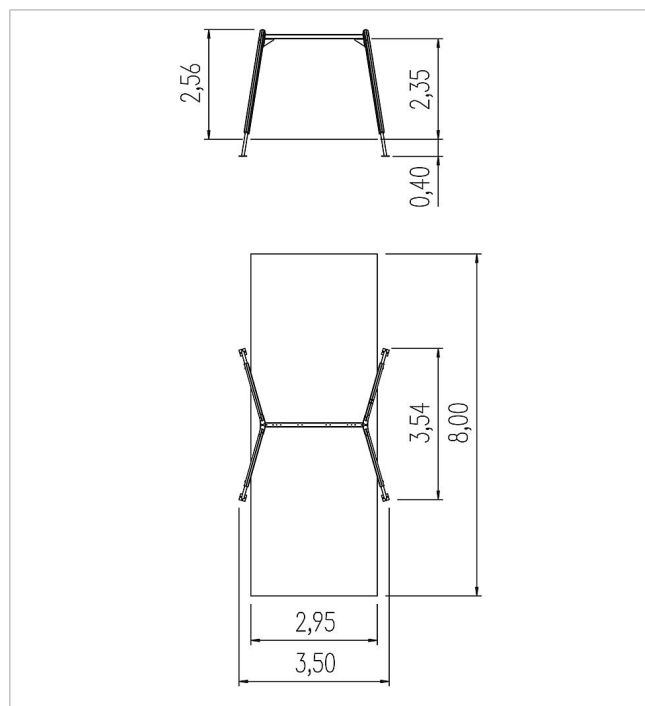

made in germany

3+

### Scope of delivery

4x post with post shoes: pine, galvanised post shoes  
1x swing beam: galvanised steel



	Material	SW pi
	Foundation level	FL 1
	Minimum space	800x350x317 cm
	Free falling height	137 cm
	Impact protection net	24,0 m <sup>2</sup>
	Foundations	4x CF or 4x PFs
	Assembly	2 persons/2 h
	Largest section	239x54x33 cm
	Heaviest section	45 kg