



# 5 55 334 0310 0

## unique swing Snake

made in germany









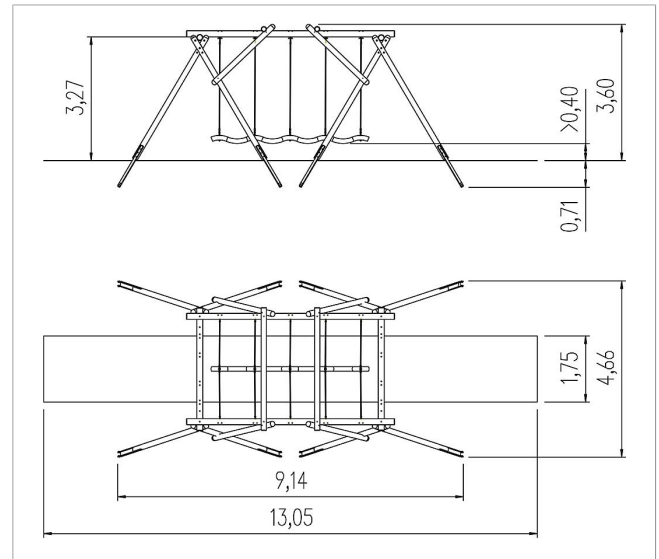

### Scope of delivery

1x swing frame: SW

1x swing snake: plastic-coated steel cable  
post shoes: galvanised steel



	Material	Larch nature
	Foundation level	FL 3
	Minimum space	1305x466x360 cm
	Free falling height	205 cm
	Impact protection net	23,0 m <sup>2</sup>
	Foundations	6x CF
	Assembly	2 persons/8 h
	Largest section	550xØ 16 cm
	Heaviest section	50 kg