



5 62 064 0

fit Tables tennis table, round GFRP







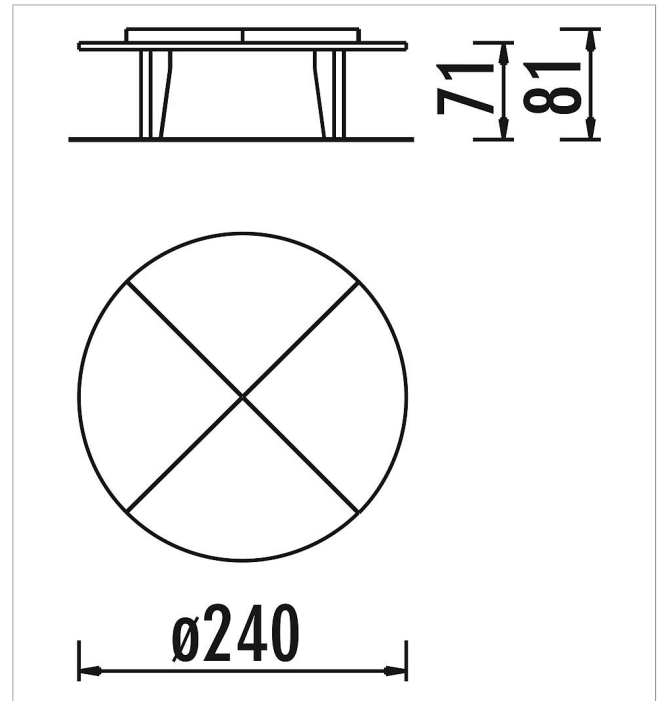

made in germany



Scope of delivery

- 1x table tennis table: GFRP
- 1x net set 4-part: stainless steel
- 4x table foot: polymer concrete



	Material	GFRP
	Foundation level	FL 3
	Minimum space	Ø 640x250 cm
	Free falling height	-
	Impact protection net	-
	Foundations	4x CF
	Assembly	2 persons/1 h
	Largest section	240x120x6 cm
	Heaviest section	130 kg