



5 67 113 0

Basis Three-seater spring rocker Beetle Ride







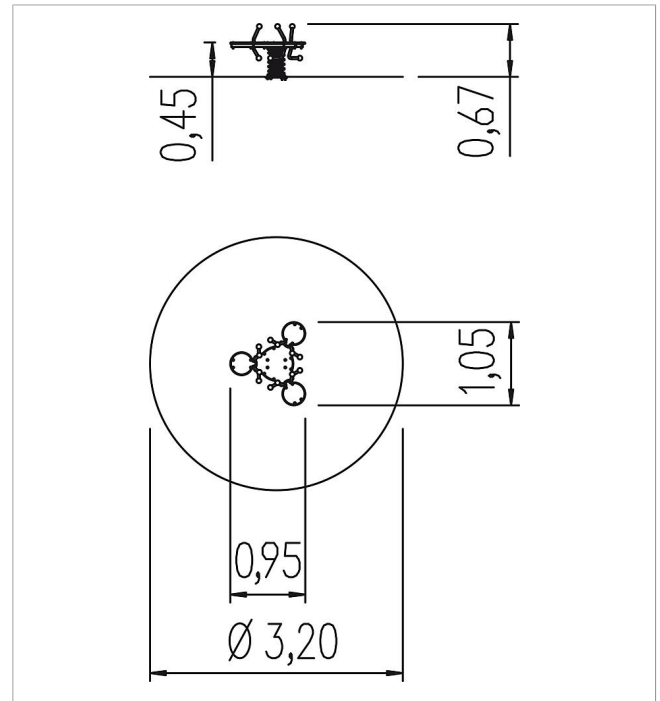

made in germany



Scope of delivery

- 1x spring see-saw-body: powder-coated steel
- 3x seats: PE
- 1x cover panel: PE
- 1x spring: spring steel



	Material	Steel, PE
	Foundation level	FL 3
	Minimum space	Ø 320x225 cm
	Free falling height	45 cm
	Impact protection net	8,5 m ²
	Foundations	1x 5591600 + 1x CF or 1x 5632100 + 1x CF
	Assembly	2 persons/1 h
	Largest section	122x41x50 cm
	Heaviest section	20 kg