



5 25 088 0410 0

unique triple swing Eagle with nest seat & swing seat







made in germany

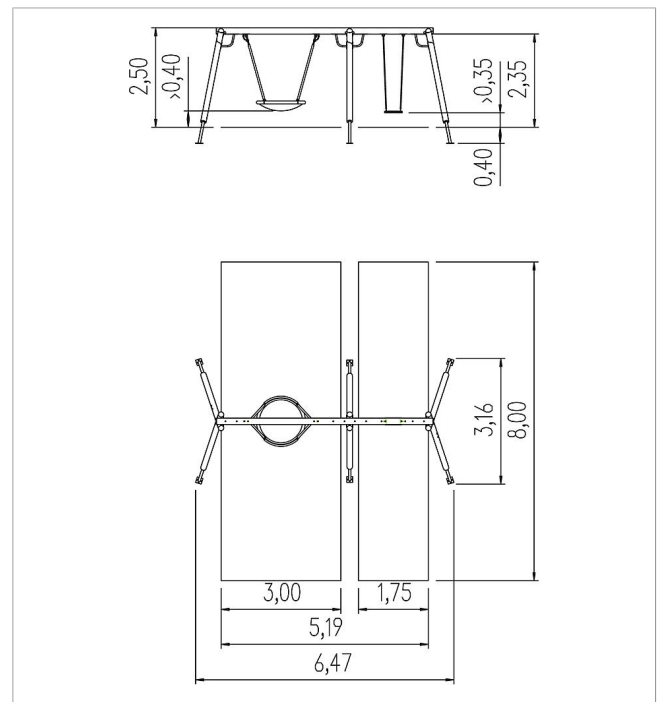

Scope of delivery

- 1x swing frame: SW, galvanised steel
- 1x swing seats with chains: stainless steel, rubber
- 1x nest swing d 120 cm: rope ring, steel cable-link mat, rubber fabric over chain suspension
- 2x swing joint: galvanised steel
- 2x cardan joint: galvanised steel
- post shoes: galvanised steel



	Material	Larch GL
	Foundation level	FL 1
	Minimum space	800x647x380 cm
	Free falling height	149 cm
	Impact protection net	41,5 m ²
	Foundations	6x CF or 6x PFs + 6x CF
	Assembly	2 persons/4 h
	Largest section	530xØ 16 cm
	Heaviest section	50 kg