

5 40 117 1013 1

**Basis Tubular add-on slide 80 degree, spiralled to right, ph 245 cm**





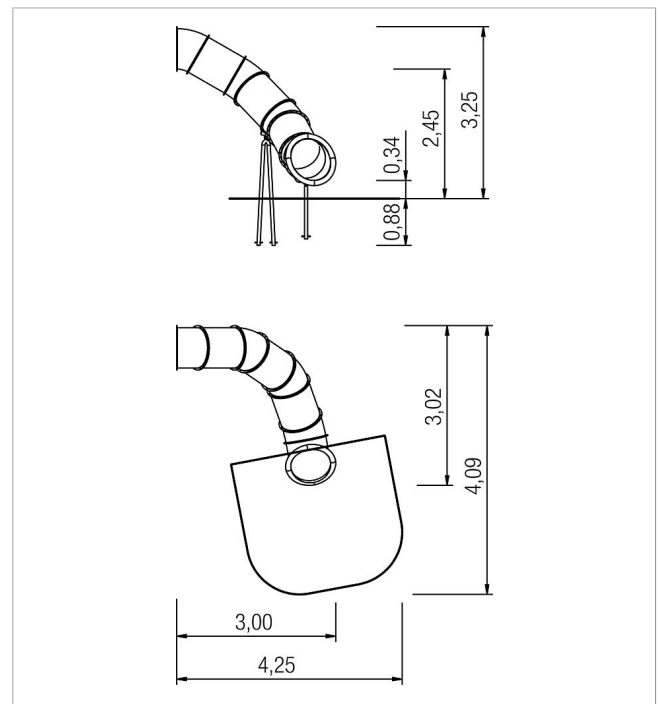

made in germany

3+

### Scope of delivery

1x tubular spiralled add-on slide ph 245 cm: GFRP



	Material	GFRP iguana
	Foundation level	FL 3
	Minimum space	425x508x415 cm
	Free falling height	34 cm
	Impact protection net	7,5 m <sup>2</sup>
	Foundations	2x CF
	Largest section	Ø 84x80 cm