



5 40 116 1210 0

**Basis Tubular slide
straight, stainless
steel, ph 295 cm**





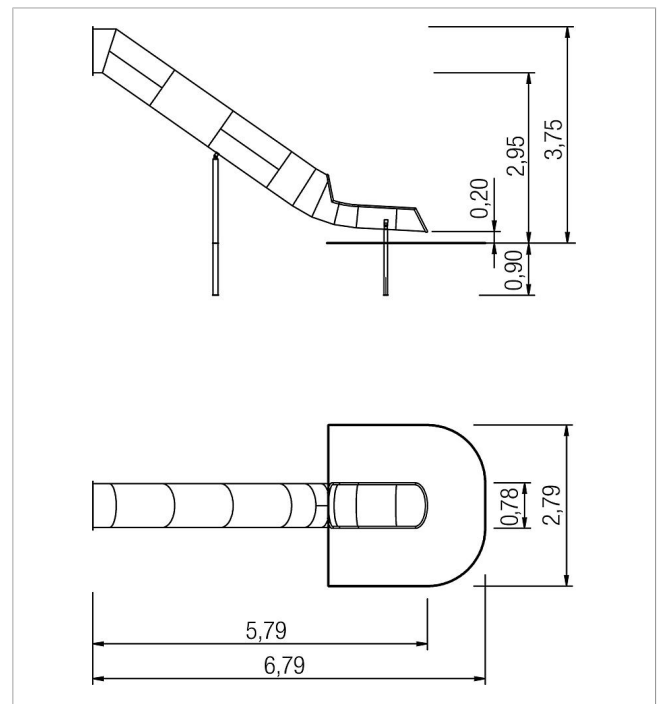

made in germany

3+

Scope of delivery

1x tubular add-on slide ph 295 cm: stainless steel



| | | |
|---|-----------------------|--------------------|
|  | Material | Stainless steel |
|  | Foundation level | FL 3 |
|  | Minimum space | 679x279x475 cm |
|  | Free falling height | 20 cm |
|  | Impact protection net | 7,5 m ² |
|  | Foundations | 2x CF |
|  | Largest section | 390x145x100 cm |
|  | Heaviest section | 145 kg |