



5 55 352 025

unique two-seater seesaw Stella







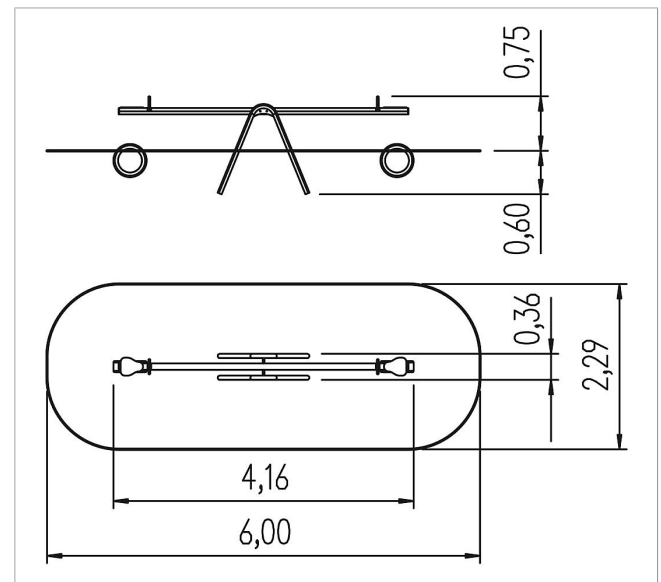

made in germany



Scope of delivery

- 1x see-saw block: galvanised and powder-coated steel
- 1x see-saw beam galvanised steel
- 2x seat: HPL
- 2x handle: stainless steel
- 2x tyres: rubber



	Material	Steel powder, grey
	Foundation level	FL 3
	Minimum space	600x229x280 cm
	Free falling height	100 cm
	Impact protection net	13,0 m ²
	Foundations	2x CF
	Assembly	2 persons/3 h
	Largest section	400x20x20 cm
	Heaviest section	50 kg