

5 66 444 1200 0

Basis Water play unit River







made in germany

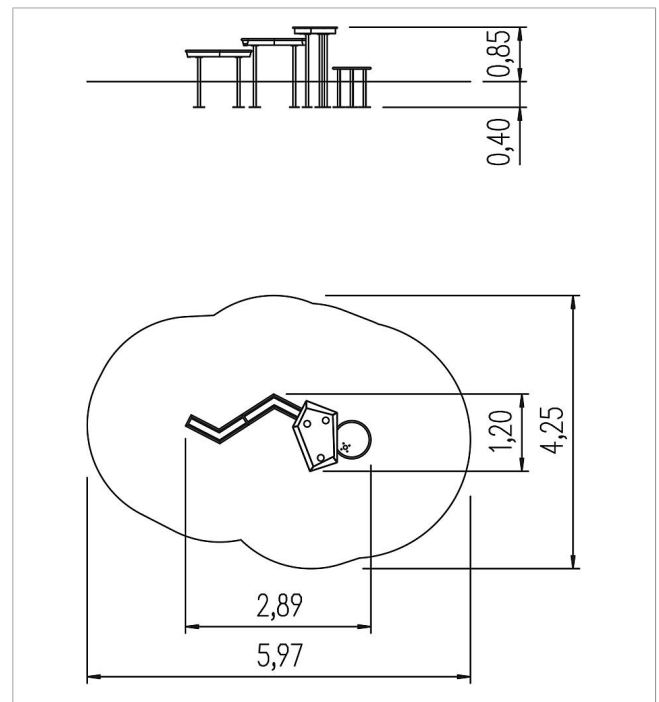

Scope of delivery

- 1x pump platform: stainless steel
- 1x valve basin pentagonal with 1 valve: stainless steel, HPL
- 1x trough bent left: stainless steel
- 1x trough bent right: stainless steel



	Material	Stainless steel, HPL
	Foundation level	FL 1
	Minimum space	597x425x255 cm
	Free falling height	75 cm
	Impact protection net	19,5 m ²
	Foundations	3x CF or 6x PFs
	Largest section	103x59x15 cm